

IMPORTANT SAFEGUARDS

WARNING: RISK OF ELECTRIC SHOCK- NEVER CONNECT TO, DISCONNECT FROM, OR SERVICE WHILE EQUIPMENT IS ENERGIZED.

WARNING: FAILURE TO FOLLOW THESE INSTRUCTIONS AND WARNINGS MAY RESULT IN DEATH, SERIOUS INJURY OR SIGNIFICANT PROPERTY DAMAGE. For your protection, read and follow these warnings and instructions carefully before installing or maintaining this equipment. These instructions do not attempt to cover all installation and maintenance situations.

READ AND FOLLOW ALL SAFETY INSTRUCTIONS

1. Disconnect power before performing work on electrical equipment.
2. Do not use outdoors.
3. Do not let power cords touch hot surfaces and do not mount near gas or electric heaters.
4. Use caution when handling batteries. Avoid possible shorting.
5. Equipment should be mounted in locations and at heights where unauthorized personnel will not readily subject it to tampering.
6. The use of accessory equipment not recommended by the manufacturer may cause an unsafe condition, and will void the unit's warranty.
7. Do not use this equipment for other than its intended purpose.
8. Servicing of this equipment should be performed by qualified service personnel.

SAVE THESE INSTRUCTIONS!

INSTALLATION

WALL MOUNT - SINGLE FACE:

1. Extend unswitched 24 hour AC supply of rated voltage to junction box or appropriate wiring (supplied by others). Leave at least eight (8) inches of slack wire. The circuit should not be energized at this time.
2. Remove the exit sign faceplate (Figure 2).
3. Remove the exit sign universal copy kit.
4. Knock out the appropriate mounting pattern and/or wire pass-thru hole on the exit back plate to fit the junction box or wiring connector being used (supplied by others).
5. Bring wires through the back of the sign and mount the exit securely in place. Screw directly to junction box if possible.
6. Connect AC supply per diagram provided (Figure 5). Insulate unused wire!
CAUTION! - Failure to insulate unused wire may result in a shock hazard or unsafe condition as well as equipment failure.
7. Route wires and secure them in place.
8. Remove any directional chevron arrows to be indicated as required from the exit stencil.
9. Replace the exit faceplate together with red fibre.
10. Turn on the AC voltage supply.

CEILING/END MOUNT - SINGLE OR DOUBLE FACE:

Follow steps 1 to 3 of Wall Mounting instructions above.

If double face is required then remove the backplate cover screw and slide the backplate down and out from exit frame. Exit signs that are specified double face will already have the second/rear faceplate installed.

On the top and both sides of the exit there are three (3) holes for the canopy- two (2) for the mounting screws and one (1) wire pass-thru hole. Knock out the three appropriate canopy mounting holes for your installation (Figure 2).

Secure the canopy to the exit sign using the supplied 1 inch screws and washer nuts and the snap wire pass-thru hole plastic bushing into the wire pass-thru hole in the centre of the canopy (Figure 3).

For ceiling mount, remove the reflective strip before wiring, after wiring install the strip back. Bring wires through the wire pass-thru and connect AC supply as described in step 6 of Wall Mounting instructions above (Figure 4).

Secure the exit to the wall or ceiling using the supplied 1 1/2 inch screws and nuts. Screw directly to junction box if possible. A universal spider plate is supplied to allow for exit sign placement adjustment or connection to a variety of electrical boxes (Figure 5).

For double face exits install the second/rear faceplate.

Follow steps 7 to 10 of Wall Mounting instructions above.

SELF-POWERED:

1. Plug the battery into the circuit board per (Figure 5) self-powered sign.

Figure 1

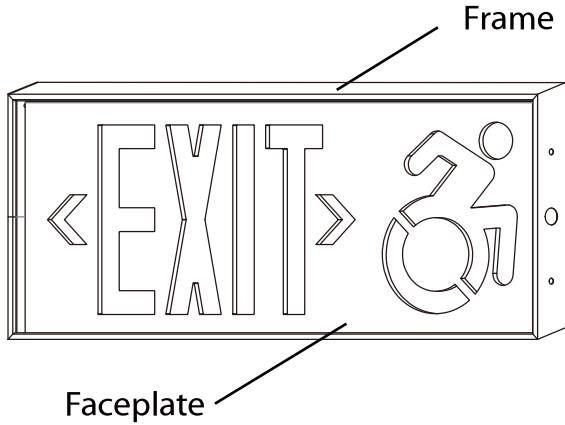

Figure 2

Install canopy kit as shown if required

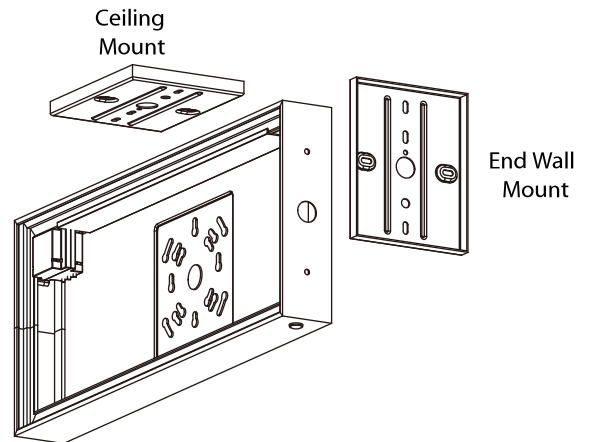

Figure 3

Remove chevrons/arrows as required

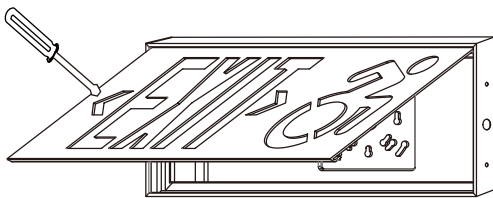

Figure 4

- ① Remove the reflective strip before wiring.
- ② Install the reflective strip after wiring.

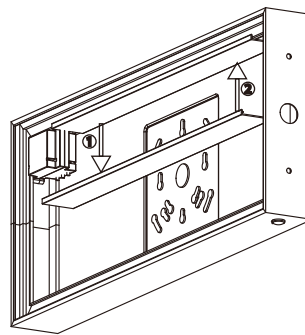

Figure 5

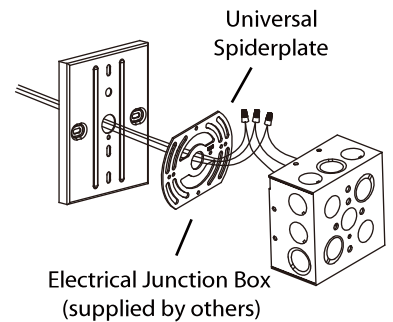
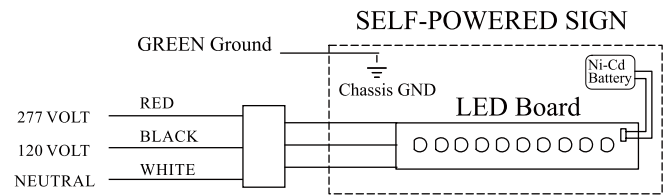
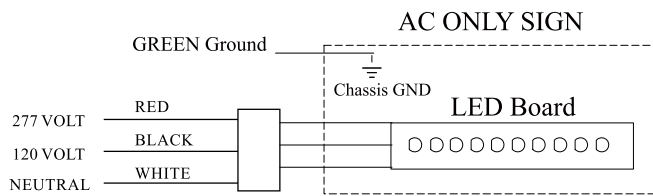
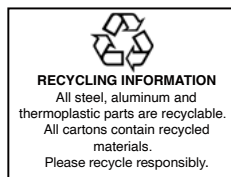

Figure 6



MAINTENANCE

1. Code requires that the equipment be tested every 30 days for 30 seconds, and that written records be maintained. Further, the equipment is to be tested once a year for 90 minutes duration as per Code. The equipment is to be repaired whenever the equipment fails to operate as intended during the duration test. Written records of test results and any repairs made must be maintained. Current strongly recommends compliance with all Code requirements.
2. Clean exit face(s) on a regular basis.
NOTE: The servicing of any parts should be performed by qualified service personnel only. The use of replacement parts not furnished by Current, may cause equipment failure and will void the warranty.



COM_604117_HI-Lo_exit_INSTR_A